

For FAQs and more information, please visit:

**[anker.com/support](https://anker.com/support)**

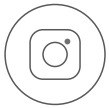

@anker\_official  
@anker\_jp



@Anker Deutschland  
@Anker Japan  
@Anker



@AnkerOfficial  
@Anker\_JP

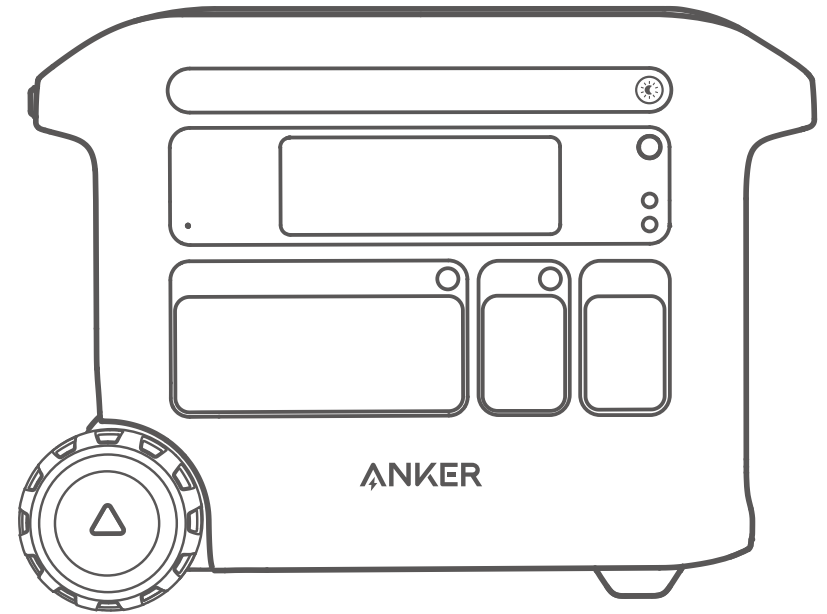

**Anker 767 Portable Power Station**  
(GaNPrime PowerHouse 2048Wh)

## **USER MANUAL**



## What's in the Box

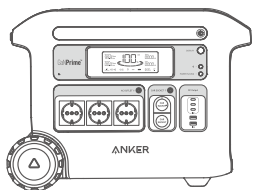

Anker 767 Portable Power Station

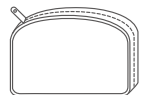

Accessories Bag



Solar Charging Cable



AC Charging Cable



Car Charging Cable



User Manual

## Overview

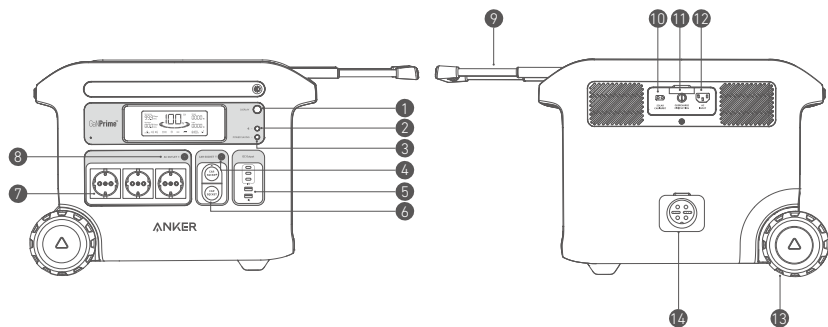

1 Display Button	8 AC Outlet Button
2 IoT Button	9 Retractable Handle (Press the button on the retractable handle and pull to extend)
3 Power Saving Button	10 Solar Input and Car Input
4 Car Socket Button	11 Overcharge Protection
5 USB Ports	12 AC Input Port
6 Car Sockets	13 Wheel(s)
7 AC Output Ports	14 Expansion Battery Port

## Recharging Your Power Station

### AC recharging (2200W Max)

Recharge your power station by connecting to a wall outlet with the AC charging cable.

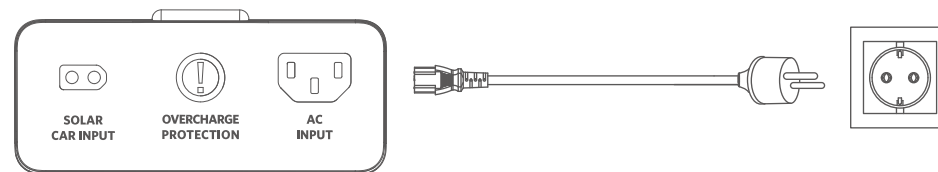

### Solar Panel Recharging (1000W Max)

Recharge your power station with a maximum solar input of 1000W by connecting up to five Anker 531 Solar Panel (200W) as shown in the figure with a solar charging cable.

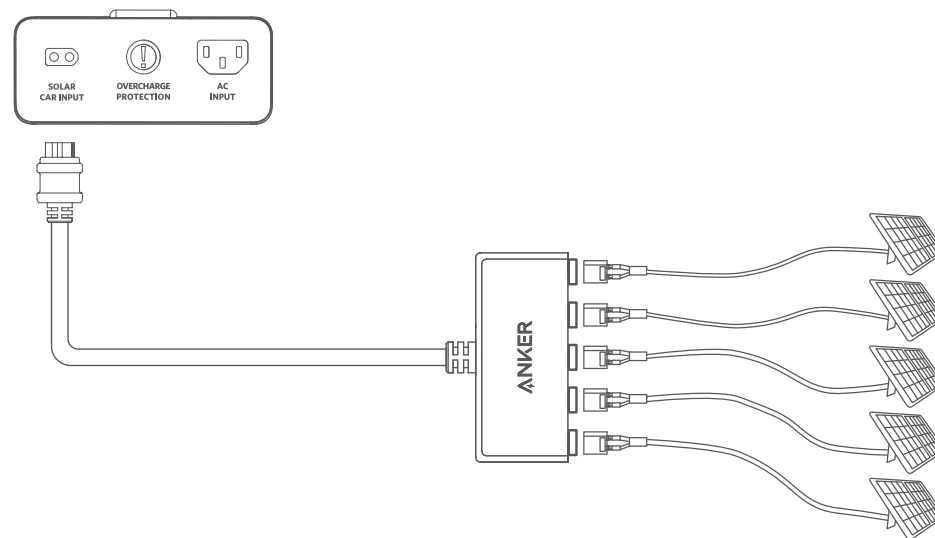

### Car Recharging

Recharge your power station by connecting to a car's output port with the car charging cable.

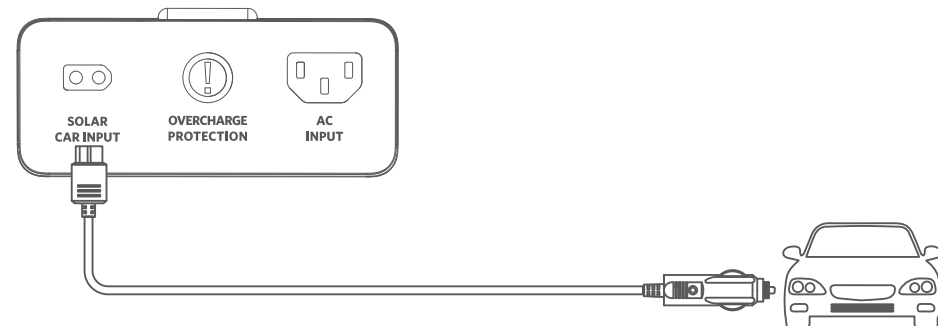

 When your portable power station only has 1% battery remaining, the "Remaining Battery" indicator will flicker to remind you to recharge.

## Powering Your Devices

### Power Saving Mode

Turning on the Power Saving mode prevents wasting energy as it automatically turns off the power station once all your devices are fully charged.

Turning off the Power Saving mode will enable stable charging over an extended period, such as for time-lapse photography or when using a CPAP machine overnight.

The AC outlets can intelligently identify whether a plug is inserted. This helps prevent power wastage by automatically turning off the power station if no plug is detected for more than 15 minutes, whether the Power Saving mode is turned on or off.

### AC Charging

Press the AC outlet button and connect your devices to the AC output ports.

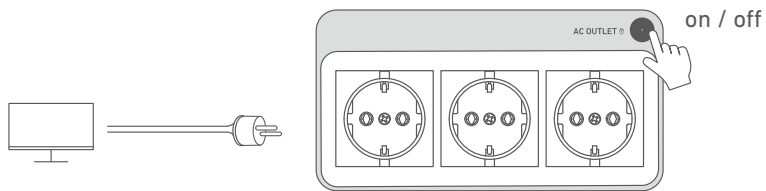

### USB Charging

Connect your devices to the USB ports.

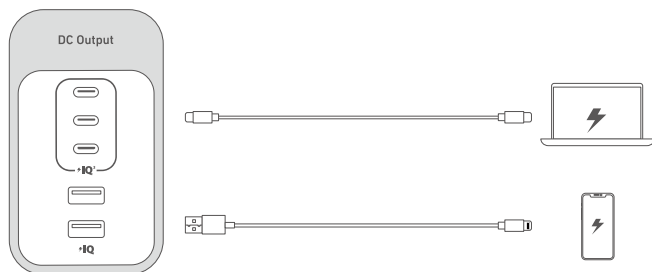

### Car Socket Charging

Turn on the car socket and connect your devices to start charging.

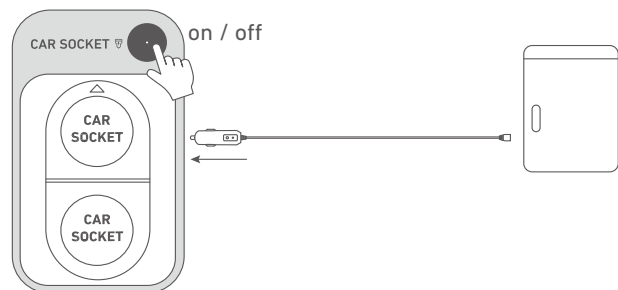

## Uninterruptible Power Supply (UPS)

To use the UPS feature, connect your power station to a wall outlet with the AC charging cable, then press the AC outlet button and connect your devices via the AC output ports.

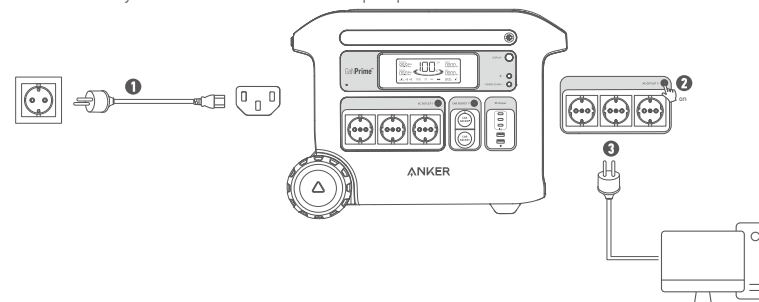

## Connect with an Expansion Battery

Your power station can be connected with an expansion battery to double the capacity to 4096Wh. Please refer to the user manual of Anker 760 Portable Power Station Expansion Battery (2048Wh) for detailed instructions.

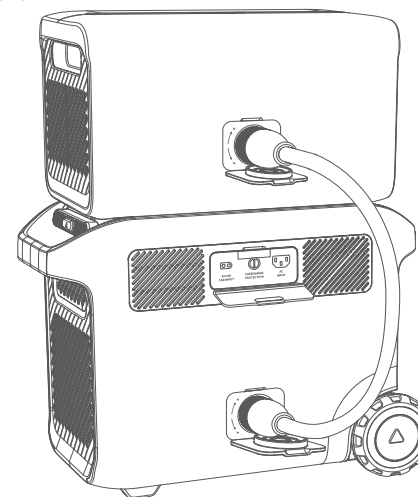

## The Anker App for Smart Control

You can remotely control your power station using the Anker App. Please download the app and its user manual by scanning this QR code.

Connect the device to a network before using the app for the first time. After connecting successfully, you can connect your devices off-grid.



# Light

## Ambient light

Press the button once to turn on the ambient light, and press again up to 2 times to switch between brightness levels.

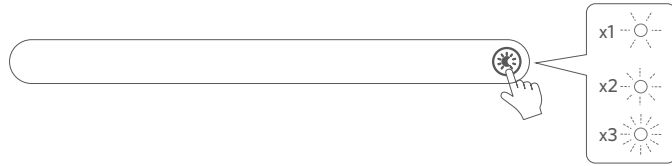

## SOS Mode

Press and hold the button for 2 seconds to turn on SOS mode.



# LCD Screen Guide

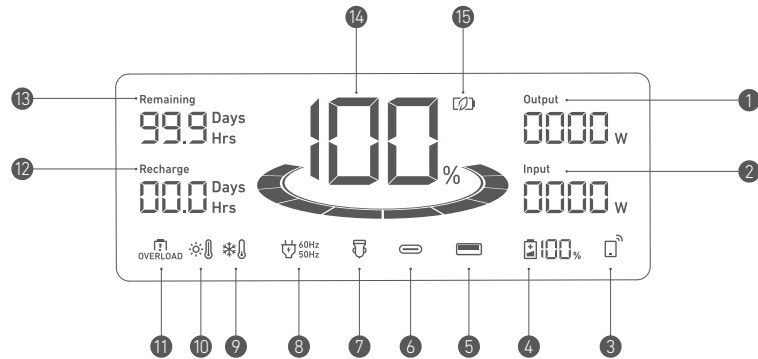

- 1 Current Output Power
- 2 Current Input Power
- 3 IoT  
Press the IoT button for 2 seconds and connect your devices through the app when this icon appears on the screen.
- 4 Remaining Battery for Expansion Battery  
When the expansion battery is connected successfully, this icon appears on the screen.
- 5 USB-A Output Port
- 6 USB-C Output Port
- 7 Car Charging
- 8 AC Charge and Voltage Frequency
- 9 Low-Temperature Alert  
When this icon shows, stop using the power station until the icon disappears.
- 10 High-Temperature Alert  
When this icon shows, stop using the power station and let it cool down until the icon disappears.
- 11 Overload Warning  
This icon appears when a port is overloaded. The port will be turned off to avoid any damage. Please remove the device causing overload.
- 12 Estimated Time to Fully Recharge
- 13 Estimated Time for Battery to Deplete
- 14 Remaining Battery for Power Station
- 15 Power Saving Mode

# FAQ

**Q1: What is the max power output of the AC output ports?**

The AC output ports can deliver a maximum of 2300W to connected devices.

**Q2: Can Anker 767 Portable Power Station power a CPAP machine?**

Yes, but make sure to turn off the Power Saving mode first.

**Q3: What should I do when using a solar charger to charge Anker 767 Portable Power Station?**

The solar input supports an 11-60V solar charger with an XT-60 connector. If you use an 11-32V solar charger, the current supports 10A max. When you use a 32-60V solar charger, the current supports 20A max. We recommend using Anker 531 Solar Panel (200W) to get the best compatibility.

**Q4: Can the USB-C ports be used to charge Anker 767 Portable Power Station (input only) or are they output only?**

The USB-C ports support output only.

**Q5: What should I do when AC recharging fails?**

If AC recharging does not work, check to see if the overload protection switch is switched on. If it is on, press down to reset and then continue recharging.

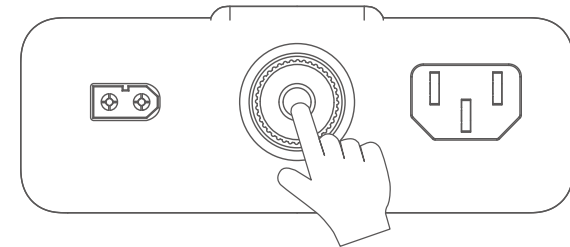

**Q6: How do I reset Anker 767 Portable Power Station?**

If your power station isn't working correctly, insert a paper clip or pin into the reset hole for 1 second for a factory reset. If the power station still doesn't work, please contact [support@anker.com](mailto:support@anker.com).

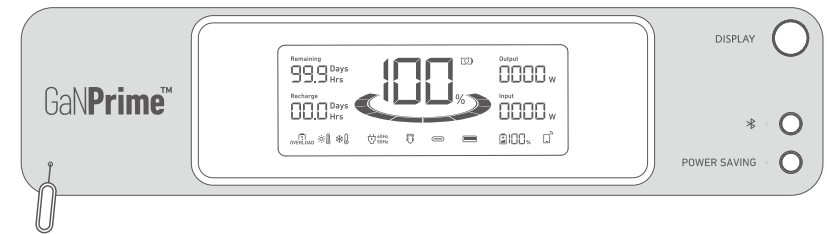

**Q7: Why is the power station not working after it hasn't been used for a long time?**

If the power station is stored at a low capacity for a long time, lithium batteries will self-consume power which may lead to a quick discharge. This often leads to poor conductivity and a reduced battery lifespan that causes the battery not to work.

**Q8: How should I store and maintain the power station?**

When storing your portable power station, please make sure that you:

- 1) Turn off all the outputs.
- 2) Store the power station in a dry and cool environment.
- 3) Check the remaining battery capacity each week. If the battery level is below 30%, fully charge the power station. Don't forget to charge it to 100% once every 3 months.

## Specifications

Cell Capacity	2048 Wh
AC Input Voltage	220-240V~ 10A Max, 50Hz
AC Input Power (Charging)	2200W Max
Solar Panel Input	11-32V $\overline{\text{---}}$ 10A; 32V-60V $\overline{\text{---}}$ 20A (1000W Max)
Car Charger Output	12V $\overline{\text{---}}$ 10A
AC Output	230V~ 10A, 50Hz, 2300W Max
USB-A Output	5V $\overline{\text{---}}$ 2.4A (2.4A Max Per Port)
USB-C Output (100W)	5V $\overline{\text{---}}$ 3A/9V $\overline{\text{---}}$ 3A/15V $\overline{\text{---}}$ 3A/20V $\overline{\text{---}}$ 3A/20V $\overline{\text{---}}$ 5A (100W Max Per Port)
UPS	20ms
Discharging Temperature	-4°F-104°F / -20°C-40°C
Charging Temperature	32°F-104°F / 0°C-40°C
Size	20.7 × 15.5 × 9.8 in / 52.5 × 39.5 × 25.0 cm
Net Weight	67.2 lb / 30.5 kg

## Attention



Not permitted on aircraft.

## IMPORTANT SAFETY INSTRUCTIONS

WARNING - When using this product, basic precautions should always be followed, including the following:

- Read all the instructions before using the product.
- To reduce the risk of injury, close supervision is necessary when the product is used near children.
- Do not put fingers or hands into the product.
- Do not expose the product to rain or snow.
- Use of an attachment not recommended or sold by the product manufacturer may result in a risk of fire, electric shock, or injury.
- To reduce the risk of damage to the electric plug and cord, pull the plug rather than the cord when disconnecting the product.
- Do not use the product in excess of its output rating. Overload outputs above rating may result in a risk of fire or injury.
- Do not use the product or attachment that is damaged or modified. Damaged or modified batteries may exhibit unpredictable behavior resulting in fire, explosion, or risk of injury.
- Do not operate the product with a damaged cord, plug, or output cable.
- Do not disassemble the product. Take it to a qualified service person when service or repair is required. Incorrect reassembly may result in a risk of fire or electric shock.
- Do not expose the product to fire or high temperatures. Exposure to fire or temperatures above 130°C may cause explosions.
- To reduce the risk of electric shock, unplug the power pack from the outlet before attempting any instructed servicing.
- Have servicing performed by a qualified repair person using only identical replacement parts. This will ensure that the safety of the product is maintained.
- When charging a device, the product may feel warm. This is a normal operating condition and should not be a cause for concern.

- When charging the internal battery, work in a well-ventilated area and do not restrict ventilation in any way.
- Do not clean the product with harmful chemicals or detergents.
- Misuse, dropping, or excessive force may cause product damage.
- When disposing of secondary cells or batteries, keep cells or batteries of different electrochemical systems separate from each other.
- Do not use or store the power station in direct sunlight for a long period, such as in a car, cargo bed, or any other place where it will be exposed to high temperatures. Doing so may cause the product to malfunction, deteriorate, or generate heat.

CAUTION: Risk of explosion if the battery is replaced by an incorrect type.

- Disposal of a battery into a fire or hot oven, or mechanically crushing or cutting off a battery, can result in an explosion.
- Leaving a battery in an extremely high-temperature environment can result in an explosion or leakage of flammable liquid or gas.
- A battery subjected to extremely low air pressure may cause an explosion or leakage of flammable liquid or gas.
- Unplug the AC power cable to disconnect from the line voltage.

### WARNING: GROUNDING INSTRUCTIONS

This product must be grounded. In the event of a malfunction or breakdown, grounding provides a path of least resistance for electrical current to reduce the risk of electric shock. This product is equipped with a cord with an equipment grounding conductor and a grounding plug. The plug must be plugged into an outlet that is properly installed and grounded in accordance with all local codes and ordinances.

WARNING – Improper connection of the equipment grounding conductor may result in an electric shock. Check with a qualified electrician if you are in doubt as to whether the product is properly grounded. Do not modify the plug provided with the product. If it does not fit the outlet, have a proper outlet installed by a qualified electrician.

### Storage and Maintenance Instructions

1. Store the product between 32°F-104°F (0°C-40°C). Avoid exposing the product to rain or using the product in a humid environment.
2. To preserve the battery lifespan, charge to 100% after using. If you plan to store your power station, recharge to 100% every 3 months.
3. Keep the product on a flat surface when using, charging, and storing.

**Bluetooth:** The Bluetooth® word mark and logos are registered trademarks owned by the Bluetooth SIG, Inc. and any use of such marks by Anker Innovations Limited (or Anker Technology Co., Limited) is under license. Other trademarks and trade names are those of their respective owners.

### Declaration of Conformity

Hereby, Anker Innovations Limited declares that the product type A1780 is in compliance with Directives 2014/53/EU & 2011/65/EU. The full text of the EU declaration of conformity is available at the following internet address: <https://www.anker.com>

Maximum output power: +4dBm (For EU)

Frequency band: 2.4G band (2.4000GHz - 2.4835GHz)

### Directive 2014/53/EU radiation exposure statement

This equipment should be installed and operated with minimum distance 20cm between the radiator and your body. This transmitter must not be co-located or operating in conjunction with any other antenna or transmitter.

### GB Declaration of Conformity

Hereby, Anker Innovations Limited declares that the product type A1780 is in compliance with Radio Equipment Regulations 2017 & The Restriction of the Use of Certain Hazardous Substances in Electrical and Electronic Equipment Regulations 2012. The full text of the GB declaration of conformity is available at the following internet address: <https://www.anker.com>.

Anker Innovations Limited | Room 1318-19, Hollywood Plaza, 610 Nathan Road, Mongkok, Kowloon, HongKong

The following importer is the responsible party (contract for EU and UK matters)

Anker Innovations Deutschland GmbH | Georg-Muche-Strasse 3, 80807 Munich, Germany

Anker Technology (UK) Limited,

GNR8, 49 Clarendon Road, Watford, Hertfordshire, WD17 1HP, United Kingdom

## Anker Portable Power Station Warranty Policy

All Anker portable power stations purchased on AnkerDirect and Anker authorized resellers come with a limited warranty ("warranty") as set out below. By using an Anker portable power station, you are agreeing to be bound by the terms of the Anker limited warranty.

We provide a 5-year limited warranty for purchases made on AnkerDirect and Anker authorized resellers. The warranty period starts from the date of purchase.

Anker's limited warranty is restricted to the country of purchase. The limited warranty is void on items taken outside the country they were originally bought in or shipped to directly from an authorized online purchase.

### Exclusions and Limitations

Not covered under warranty:

- Products that are damaged or modified.
- Products operated with a damaged cord, plug, or output cable.
- Products that are disassembled.
- Products that are cleaned with harmful chemicals or detergents.
- Non-quality related issues (after 30 days of purchase).
- Products purchased from unauthorized resellers.
- Products without sufficient proof of purchase.
- Products that have been refunded.
- Products with an expired warranty.
- Lost, stolen, or free products.
- Damage from outside sources.
- Repairs through 3rd parties.
- Damage from misuse of products (including, but not limited to falls, use of the product in excess of its output rating, exposure of the product to rain or snow, extremely low air pressure, extreme temperatures).
- Purchases from illegitimate resources.
- Batteries that are damaged when not used for a long time or not properly maintained according to the user manual.

### Anker is Not Liable For:

- Loss of data incurred from the use of Anker products.
- Returning personal items sent to Anker.

When returning items with a prepaid shipping label provided by Anker, Anker takes responsibility for any damage or loss incurred in transit. When returning items for non-quality issues, the buyer assumes responsibility for any damage or loss incurred in transit. Anker does not provide refunds for items damaged in transit due to non-quality related warranty claims.

### Refund and Warranty Claims

We offer a 30-day money-back guarantee for any reason as well as warranty claims for quality-related issues.

For more details please refer to [www.anker.com/anker-portable-power-station-warranty-policy](http://www.anker.com/anker-portable-power-station-warranty-policy)

### For warranty claims, you can send an email to:

US/CA/UK/DE/JP market: [support@anker.com](mailto:support@anker.com)

MEA market: [support.mea@anker.com](mailto:support.mea@anker.com)

CN market: [CEC-CN@anker.com](mailto:CEC-CN@anker.com)

### Or you can call us at:

US/CA: +1 (800)988 7973    UK: +44(0)1604 936 200  
DE: +49(0)69 9579 7960    JP: +81 03 4455 7823  
UAE: +971 8000 320 817    KSA: +966 8008 500 030  
Kuwait: +965 2206 9086    Egypt: +20 8000 000 826  
AU: +61 3 8331 4800    TR: +90(850)460 1414  
RU: +8(800)511 8623    CN: +86 400 0550 036  
KR: +82 0216 7070 98    IN: +91 1800 3138 831  
Middle East & Africa: +971 4242 8633

### Valid Proof of Purchase

Please refer to: <https://us.anker.com/policies/refund-policy>

### Shipping Costs Must Be Covered by the Buyer in the Following Situations

Please refer to: <https://us.anker.com/policies/refund-policy>

This page is attached to the Anker warranty page, and Anker reserves the right of final interpretation of the content.

## Customer service

**DE:** Kundenservice  
**IT:** Servizio Clienti  
**TR:** Müşteri Hizmetleri

**ES:** Atención al Cliente  
**PT:** Serviço de Apoio ao Cliente  
**简体中文:** 客服支持

**FR:** Service Client  
**RU:** Обслуживание клиентов

:AR خدمة العملاء



**EN:** 5-Year Limited Warranty\*  
**ES:** Garantía limitada de 5 años\*  
**IT:** Garanzia limitata di 5 anni\*  
**RU:** 5-летняя ограниченная гарантия  
**简体中文:** 5年有限保修

**DE:** 5 Jahre eingeschränkte Garantie\*  
**FR:** Garantie limitée de 5 ans\*  
**PT:** 5 anos de garantia limitada  
**TR:** 5 Yıllık Sınırlı Garanti

:AR ضمان محدود لمدة 5 سنوات

\***EN:** Please note that your rights under applicable law governing the sale of consumer goods remain unaffected by the warranties given in this Limited Warranty.

**DE:** Die gesetzlichen Gewährleistungspflichten bleiben von der beschränkten Herstellergarantie unberührt.

**ES:** Tenga en cuenta que los derechos que le conceden las leyes aplicables que rigen la venta de bienes de consumo no se ven afectados por las garantías que proporciona esta garantía limitada.

**FR:** Notez que vos droits dans le cadre de la législation régissant la vente de biens de consommation ne sont pas affectés par les garanties accordées dans cette garantie limitée.

**IT:** Si prega di notare che i diritti del cliente ai sensi della legge applicabile in materia di vendita di beni di consumo non sono influenzati dalle garanzie concesse dalla presente Garanzia limitata.



**EN:** Lifetime technical support  
**ES:** Asistencia técnica permanente  
**IT:** Supporto tecnico per l'intero ciclo di vita  
**RU:** Пожизненная техническая поддержка  
**简体中文:** 终身技术支持

**DE:** Technischer Support für die Produktlebensdauer  
**FR:** Assistance technique à vie  
**PT:** Suporte técnico vitalício  
**TR:** Ömür Boyu Teknik Destek

:AR دعم فني مدى الحياة



[support@anker.com](mailto:support@anker.com)  
[support.mea@anker.com](mailto:support.mea@anker.com) (For Middle East and Africa Only)



(US/CA) +1 (800)988 7973    (UK) +44 (0) 1604 936200  
(DE) +49 (0) 69 9579 7960    (Middle East & Africa) +971 42428633  
(UAE) +971 8000320817    (KSA) +966 8008500030  
(Kuwait) +965 22069086    (Egypt) +20 8000000826  
(AU) +61 3 8331 4800    (TR) +90 0850 460 14 14  
(RU) +8 (800) 511-86-23    (中国) +86 400 0550 036  
(日本) 03 4455 7823    (한국) +82 02-1670-7098  
(India) +91 18003138831